

Universal HGV towing brackets

Please pay attention to the D-value of each component!

Towing bracket

with integral anderrun guard
order no. 313404600001
and towball
order no. 329103600001

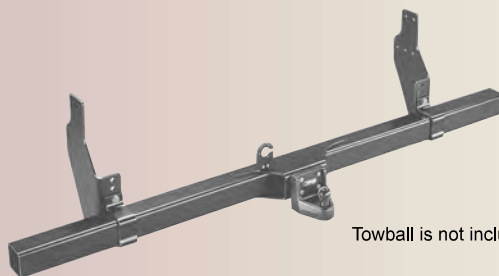

under run guard
approval no.: e13-6131

Towball is not included.

	order no.		D-value kN				
Towing bracket with integral anderrun guard for HGV. Swap system permitted.	313404600001	69,0	25,1	150	3000 3500	17000 9400	
towball recommended	329103600001	8,2	25,1	120	3000 3500	17000 9400	

Towing bracket

with integral anderrun guard
order no. 342179600001
and towball
order no. 329103600001



under run guard
approval no.: e13-6130

Towball is not included.

	order no.		D-value kN				
Towing bracket with integral anderrun guard for HGV. Swap system permitted.	342179600001	76,0	23,5	150	3500	z.B. 7500	
towball recommended	329103600001	8,2	25,1	120			

Towing bracket

with integral anderrun guard
order no. 314052600001
and towball
order no. 329062600001

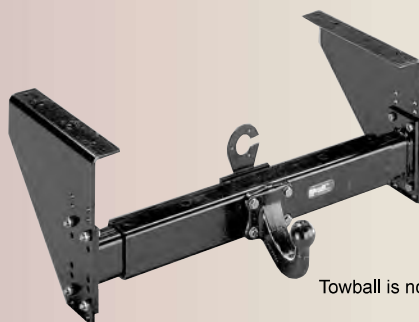

Towball is not included.

	order no.		D-value kN				
Towing bracket for HGV Swap system permitted.	314052600001	27,2	16,4	100	2000	10000	
towball recommended	329062600001						

Universal HGV-electrical kits for 12V	order no.	car specific	flash control	coding	PDCcut off	perma- nent plus	charging line	electrical connec- tion	moun- ting time	
	300201300113	-	A	-	-	D1	L1	V		

Technical data for universal HGV towbars

all measurements in mm

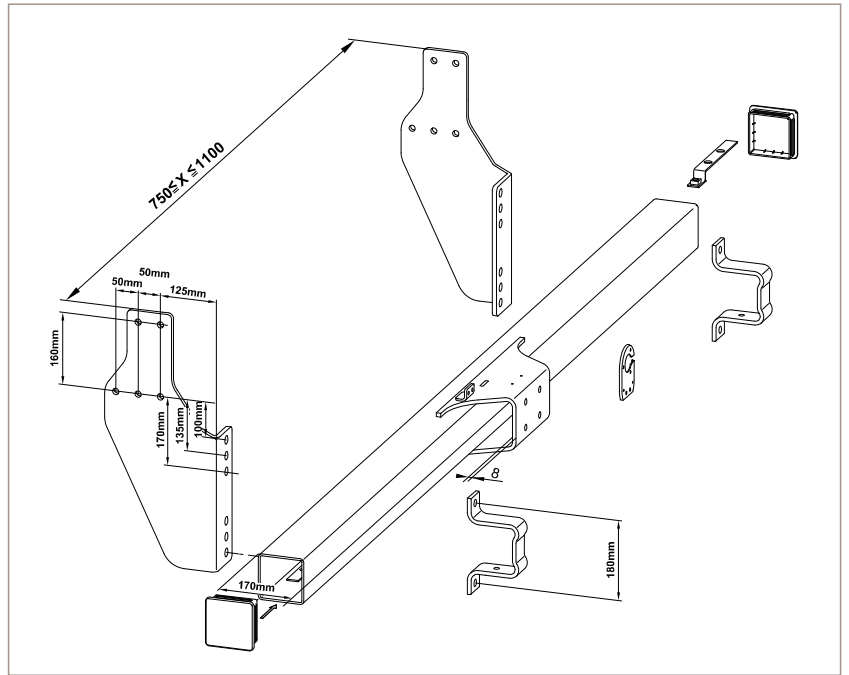

342 179

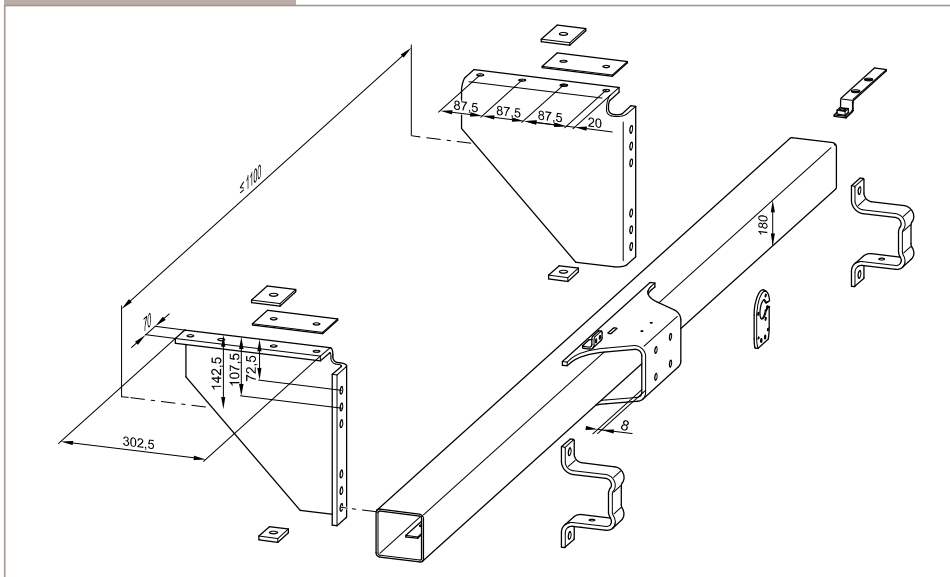





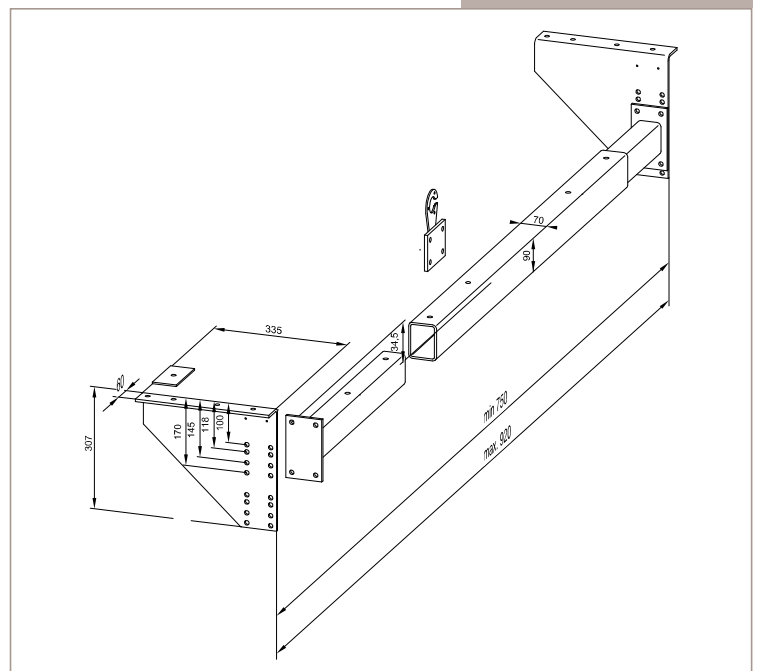

313 404

314 052

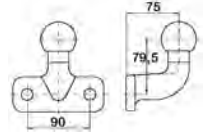
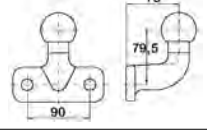
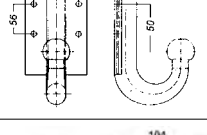
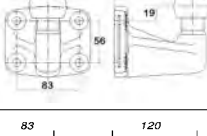

Towing brackets universally applicable due to 2-dimensional adjustment (height and width)

Towballs and Couplings for HGV and Off-Road Vehicles

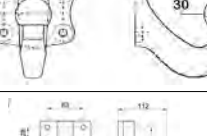
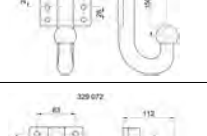
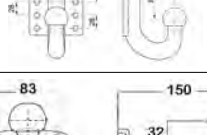
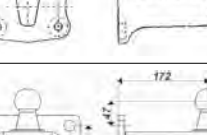
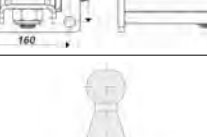
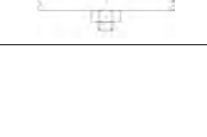
	order no.		D-Value	 kg	 kg	kg 	
	329076600001	2,4	17,0	150	2.500 or 2.200 or 2.000	5.600 or 8.100 or 11.500	
	incl. 2 screws M 16 x 50, 8.8						
	329080600001	2,4	20,0	150	2.500 or 2.800 or 3.500	11.000 or 7.500 or 4.880	
	incl. 2 screws M 16 x 50, 8.8						
	329042600001	4,4	17,2	100	2.800 or 2.500 or 2.000	4.700 or 5.800 or 14.200	
	329059600001	3,0	23,5	150	2.800 or 3.100 or 3.500	15.000 or 10.000 or 7.500	
	329103600001	8,5	25,1	120	3.500 or 2.500 or 3.000	9.400 or 40.000 or 17.000	
	329062600001	3,6	23,5	150	2.800 or 3.100 or 3.500	15.000 or 10.000 or 7.500	
	329071600001	4,1	17,5	150	2.500 or 2.800 or 3.500	6.200 or 4.900 or 3.600	
	329072600001	3,7	17,5	150	2.500 or 2.800 or 3.500	6.200 or 4.900 or 3.600	
	329089600001	2,8	17,5	150	2.800 or 2.500 or 3.500	4.900 or 6.200 or 3.600	
	329096600001	13	22,64	120	2.700 or 3.000 or 3.300	15.000 or 10.000 or 7.500	
	incl. 4 screws M 20 x 60, 8.8						
	900008600001	1,05	18,5	150	2.800 or 2.500	5.600 or 7.500	

Mounting parts for Couplings



traverse of the towing vehicle or towing bracket	towball or coupling (order no. ends with ...600001)	screw kit*	
8 - 12 mm	329 042 329 059, 329 062, 329 071, 329 072 329 060, 329 089, 329 103	900 040 632 340 900 045 632 325 900 055 632 552	
15 - 20 mm	329 042, 329 057, 329 062, 329 071, 329 072 329 059 329 060, 329 103	900 050 632 424 900 055 632 552 900 060 632 523	
60 - 65 mm	329 042, 329 062, 329 071, 329 072 329 059 329 060, 329 103, 329 089	900 095 632 553 900 100 632 527 900 105 632 554	
65 - 70 mm	329 042, 329 062, 329 071, 329 072 329 059 329 060, 329 103, 329 089	900 100 632 527 900 105 632 554 900 110 632 505	
70 - 75 mm	329 042, 329 062, 329 071, 329 072 329 059 329 060, 329 103, 329 089	900 105 632 554 900 110 632 505 900 115 632 524	
75 - 80 mm	329 042, 329 062, 329 071, 329 072 329 059 329 060, 329 103, 329 089	900 110 632 505 900 115 632 524 900 120 632 516	
80 - 85 mm	329 042, 329 062, 329 071, 329 072 329 059 329 060, 329 103, 329 089	900 115 632 524 900 120 632 516 900 125 632 504	
85 - 90 mm	329 042, 329 062, 329 071, 329 072 329 059 329 060, 329 103, 329 089	900 120 632 516 900 125 632 504 900 130 632 539	
90 - 95 mm	329 042, 329 062, 329 071, 329 072 329 059 329 060, 329 103, 329 089	900 125 632 504 900 130 632 539 900 135 632 379	

* Each kit contains: 4 screws M10 10.9, 4 nuts, 8 washers.
4th - 6th position of the part no. indicates the length of the screws in mm.

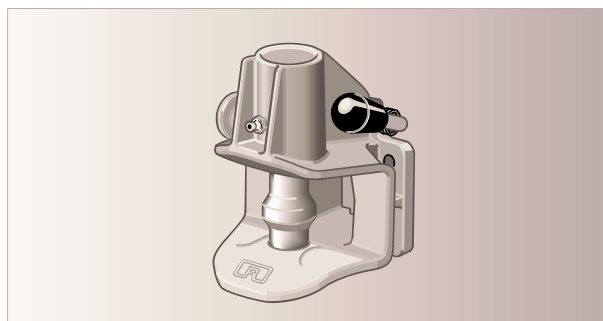
Coupling bolt





Coupling bolt
Rockinger-Nr. 243A11000

order no.	screw-hole circle mm	D-Value kN	Dc-Value kN (depends on the height of the ball)	 kg	 kg	
342090600001	83 x 56	18,0	min. 18,0 max. 30,0	5,0	250	

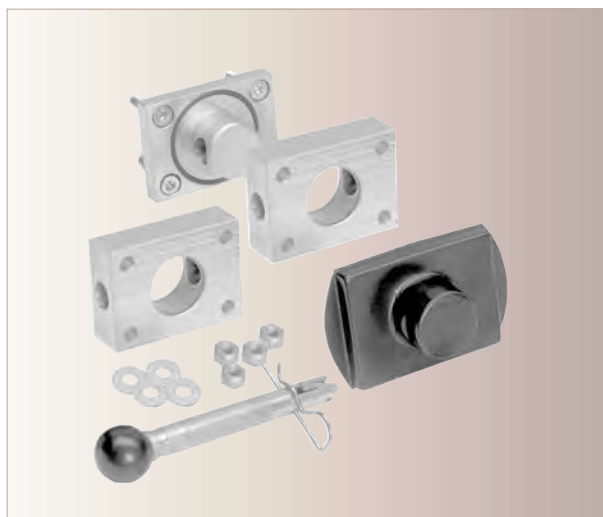
Swap system



order no.	set	screw-hole circle mm	D/Dc-Value kN	 kg	 kg
329064600001	1 ground plate 2 exchangeable plates 1 cover	83 x 56	18,5	3,5	120

Application in association with:



towball

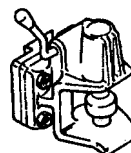

coupling system

*screws / mounting parts (depending on towing brackets and couplings) regard below.

Mounting parts for swap system

screw kit*	Towball or coupling on adapting plate	flange	screws
900 050 636 186	329 042	5 - 10 mm	M 10 x 50
900 055 636 187	329 059, 329 062, 329 072, 329 089 Rockinger-Bolzenkupplung	10 - 15 mm	M 10 x 55
900 060 636 188	329 060, 329 103	15 - 20 mm	M 10 x 60

screw kit*	base plate on towing vehicle or towbar	screws
900 040 636 176	8 - 12 mm	M 10 x 40
900 100 636 180	70 - 75 mm	M 10 x 100
900 110 636 182	80 - 85 mm	M 10 x 110
900 130 636 185	95 - 105 mm	M 10 x 130

* Each kit contains

4 screws M10 (10.9)
4 nuts M10
4 washers 10,5

4th - 6th position of the part no. indicates the length of the screws in mm.

Special Couplings



Adapter 2-hole-fixing (90 mm) to 4-hole-fixing (83 x 56 mm)

order no.	900 001 005 062
max. total weight kg	3500
vertical load kg	140
D-value kN	20,2
weight kg	3,0

Special Couplings



order no.	329 095 600 001	
flange plate	130 X 90	
hole Ø mm	17	
diameter mm	2-holes 90	
max. total weight kg	3500	
D-value kN ball	10,3	
D-value kN flange	17,2	
vertical load kg ball	100	
vertical load kg flange	120	
weight kg	3	



order no.	329 091 600 001	
flange plate	114 x 73	
hole Ø mm	17	
diameter mm	2-holes 90	
max. total weight kg	3500	
opening mm	50 Ø	
D-value kN	27,5	
vertical load kg	150	
weight kg	3,5	



order no.	329 094 600 001	329 090 600 001 discontinued
flange plate	122 x 91	122 x 91
hole Ø mm	17	11
diameter mm	4-holes 90 x 40	4-holes 83 x 56
max. total weight kg	3500	3500
D-value kN	31	31
vertical load kg	340	340
weight kg	5,2	5,2



order no.	342 171 600 001	342 192 600 001	900001001850
set	1 ground plate 1 towball (2-holes) 1 socket holder 1 mounting kit	1 ground plate 1 towball (4-holes) 1 socket holder 1 mounting kit	1 ground plate 1 mounting kit
D/Dc-vlaue	17,17	21,69	17,17
weight kg	8	11	2,7
vertical load kg	140	140	140
towing capacity kg	3500	3500	2700

Accessories



Towball cover

(10 pcs.)

order no.: 917 034 630 010

package 100 pieces: order no. 917 034 630 100
package 800 pieces: order no. 9170 34 630 101



Towball cover blue "Baseball cap"

(10 pcs.)

order no.: 300 010 001 909

package 50 pieces: order no. 300 050 001 909



Snap gauge

order no.: 900 001 535 051



Breakaway Cable Bracket for trailer breakaway cable

for the safety brake cable of the trailer

order no.: 935 211 627 001



Breakaway Cable Bracket for trailer breakaway cable 50 mm Ø

for the safety brake cable of the trailer

order no.: 921 540 627 001



Breakaway Cable Bracket for trailer breakaway cable 56 mm Ø

for the safety brake cable of the trailer

order no.: 905 243 627 001



Breakaway Cable Bracket for trailer breakaway cable 84 mm Ø

for the safety brake cable of the trailer

order no.: 905 276 627 001

Accessories



Presentation rack for towbars

(towbars are not included)

order no.: 300 100 600 001

Steps



Step

for Ford Transit van / minibus
only in conjunction with Westfalia towbar 307260600001

order no.: 307 267 600 001



Step

for Mercedes-Benz Sprinter and VW LTII -03/06 (van and minibus).
Only in conjunction with towbars WAM no.:
313 087/088/103/149/152/154/155 600001

order no.: 313 132 600 001



Step

for Mercedes-Benz Sprinter II and VW LT Crafter 03/06-
(van and minibus)
Only in conjunction with towbars WAM no.:
313 267/272/273/376 600001

order no.: 313 285 600 001



Step universal

for all universal HGV towbars with 4 hole towballs and
universal HGV towbars with 2 hole towballs with a hole
spacing of 90 mm
e.g. Citroen Jumper, Fiat Ducato, Mercedes Sprinter,
Peugeot Boxer, VW Crafter

order no.: 313 440 600 001

Side caps for towing brackets



Side cap (2 pcs.) (measurements: 100x100 mm)

342035, 332110, 342076/313146/313192/313193,
313404/342179

order no.: 900 001 503 587



Side cap (2 pcs.) (measurements: 95x65 mm)

321322/202/203, 335099/153, 332033/093/340018,
340042/340043, 313222

order no.: 921 201 630 101

Spare parts for detachable towbars



Key for lock automatic towball

(package 2 pcs.)

*The last two digits are the numbers that appear on the key head or that you have noted in your manual. Declaration and procedure for ordering keys please find on our website www.westfalia-automotive.com.

order no.: 942 001 513 2xx



Cover for lock automatic towball

(package 10 pieces)

order no.: 905 112 630 101



Master key set for detachable towbars

order no.: 942 001 513 999



Skai leather zip bag (for all detachable towbars)

order no.: 900 001 504 923



Metal nut

(incl. 4 steel balls, 1 circlip)
of the ball up to 36 mm

order no.: 903 062 622 101



Metal nut

(incl. 4 steel balls, 1 circlip)
of the ball up to 40 mm

order no.: 914 234 622 101



Ring spanner

for metal nut 36 + 40 mm

order no.: 903 062 622 102

Adapter and plugs



Adapter, short 7/13

from car 7-pins to trailer 13-pins

order no.: 300 100 310 107



Adapter, short 13/7

from car 13-pins to trailer 7-pins

order no.: 300 100 320 113



Plug 13p

order no.: 900 001 506 533



Adapter 13p West

from car 13-pins (DIN/ISO 11446) to trailer 7-/13-pins West

order no.: 900 001 506 997

Sockets and seals



Socket 13-pins

Screw connection (option for cable outlet in the side w. seal 900 001 507 001)
cable outlet on side, with rear fog light disconnecting contact

order no.: 900 001 506 001



Socket 13-pins

Contact sockets with solder connections, double microswitch, axial cable outlet

order no.: 900 001 506 037



Socket 7-pins

Screw connection, microswitch changer, axial cable outlet (N-version DIN/ISO 1724)

order no.: 900 001 506 054



Socket 13-pins

Flat version 40 mm high, crimp contact, microswitch, cable outlet on right side

order no.: 900 001 506 124



Socket 13-pins

West plug system
Screw connection without rear fog light disconnecting contact, axial cable outlet
similar to (N-Version DIN/ISO 1724) + 6 contacts

order no.: 900 001 506 210



Socket 7-pins

Crimp connection, without rear fog light disconnecting contact, axial cable outlet (N-version DIN/ISO 1724)

order no.: 900 001 506 384



Socket 13-pins

Screw connection, microswitch
cable outlet on side

order no.: 900 001 506 386

Sockets and seals



Socket 13-pins

Screw connection, microswitch
axial cable outlet

order no.: 900 001 506 387



Socket 7-pins

Screw connection, rear fog light disconnecting contact,
cable outlet on right side
(N-version DIN/ISO 1724)

order no.: 900 001 506 397



Socket 7-pins

Screw connection, rear fog light disconnecting contact, axial
cable outlet
(N-version DIN/ISO 1724)

order no.: 900 001 506 424



Socket 13-pins

Screw connection (option for cable outlet in the side w. seal
900 001 507 001)
axial cable outlet, without rear fog light disconnecting
contact

order no.: 900 001 506 439



Socket 7-pins

7p. Extension socket for English vehicle market
(S-version DIN/ISO 3732)

order no.: 900 001 506 656



Socket 13-pins

Screw connection (option for cable outlet in the side w. seal
900 001 507 001)
axial cable outlet, with rear fog light disconnecting contact

order no.: 900 001 506 680

Accessories for sockets



Screw connection with bellows, cable outlet on right side

package 10 pieces: order no. 900 010 503 924

order no.: 900 001 503 924



Socket seal, 2 axial cable outlets

order no.: 900 001 506 010



Socket seal with bellows, axial cable outlet

package 10 pieces: order no. 900 010 506 024

order no.: 900 001 506 024



Substitute socket housing 52 mm high, axial cable outlet

order no.: 900 001 506 438



Seal for 900 001 506 439/680/001/, outlet on right side, 2 pieces

package 10 pieces: order no. 900 010 507 001

order no.: 900 001 507 001



Additional socket plate for 2nd socket

(GB market)

order no.: 900 001 535 208



Cable support sleeve angled, for 40 mm car body openings, cable diameter: 6 - 14 mm

(package 10 pieces)

order no.: 900 010 303 015

Accessories for sockets



Socket seal, axial cable outlet

(package 10 pieces)

order no.: 900 010 506 531



Socket base plate for slit holders

(package 10 pieces)

order no.: 900 010 506 616



Spare part kit folding plastic socket holder

with slot

order no.: 907 292 608 001



Substitute socket holder with slash, universal

package 10 pieces: order no. 920 036 608 110

order no.: 920 036 608 001



Spare part kit folding plastic socket holder

without slot

order no.: 921 504 608 001

Accessories



Vehicle tester trailer simulation 12 V, for function control and fault simulation

order no.: 900 001 300 198



Signal generator

6 - 24 Volt

order no.: 900 001 300 200



Cable connector for cable diameter 0.35-0.75 m²

(package 4 pieces)

order no.: 900 001 506 102



C2 light compl. 12 V (short version)

long version: order no. 900 001 507 809

order no.: 900 001 506 547



Cable connector

for cable diameter 1.0-2.5 m²

order no.: 900 010 507 391



Relay adapter

(for adapting various different relay assignments)

order no.: 900 061 305 001



C2 cable bridge for older Vauxhall vehicles

order no.: 914 083 303 020

Cycle carrier and accessories



Bicycle carrier bikelander

with hybride LED lights

- Measurements (W/H/D): 580x220x690 mm (hinged) / 686x1250x678 mm (expanded)
- Weight: 17 kg
- Max. payload: 60,0 kg
- Wheelbase: up to 1300 mm
- Bicycle frame: up to 80 mm diameter
- Section width: up to 60 mm

order no.: 350 050 600 001



Bicycle carrier bikelander classic

with conventional lights

- Measurements (W/H/D): 580x220x690 mm (hinged) / 686x1250x678 mm (expanded)
- Weight: 17 kg
- Max. payload: 60,0 kg
- Wheelbase: up to 1300 mm
- Bicycle frame: up to 80 mm diameter
- Section width: up to 60 mm

order no.: 350 053 600 001



Box (for BC 60, BC 70 & bikelander/classic)

- Measurements (W/H/D): 1170 x 600 x 425 mm
- Weight: 15,0 kg
- Max. payload: 45,0 kg
- Capacity: 200 l
- Colour: anthracite

order no.: 350 002 600 001



Platform (for BC 60, BC 70 & bikelander/classic)

- Measurements (W/H/D): 1290 x 230 x 413 mm
- Weight: 6,0 kg
- Max. payload: 54,0 kg
- Colour: anthracite

order no.: 350 004 600 001



Expansion rail for the 3rd bicycle (for BC 60 & BC 70)

for models Portilo (year of construction: -12/11: order no. 350 001 600 001

order no.: 350 014 600 001



Expansion rail for the 3rd bicycle (for bikelander/classic)

order no.: 350 055 600 001

Cycle carrier and accessories



Bag (for BC 60 & BC 70)

For clean storage of the cycle carrier
(10 pieces: order no.: 350008600010)

order no.: 350 008 600 001



Bag (for bikelander/classic)

For clean storage of the cycle carrier

order no.: 350 013 600 001



Drive up ramp

for easy loading of heavy cycles

(for BC 60, BC 70 & bikelander/classic)

for models Portilo (year of construction: -12/11: order no.
350 009 600 001)

order no.: 350 020 600 001



Additional brake light (for BC 60, BC 70 & bikelander/classic)

Legal requirement if the bikes obscure the 3rd brake light of
the vehicle

order no.: 350 000 305 173



Gear belt extension (for BC 60, BC 70 & bikelander/classic)

order no.: 950 000 622 002



Wall mounting bracket (for BC 60 & BC 70)

Steel construction for easy storage of the BC 60 cycles
carrier to any wall

order no.: 350 006 600 001



Presentation rack cycle carrier (for BC 60, BC 70 & bikelander/classic)

(cycle carrier is not included)

order no.: 950 003 631 001